

Series 7 valves and solenoid valves

VDMA 24563 (ISO 15407-1)
5/2 - 5/3-way CC CO CP

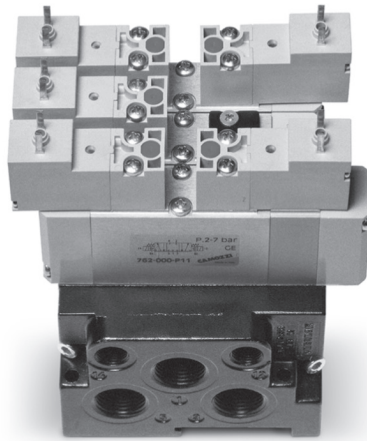

Size 26 mm (VDMA 24563-01)
Size 18 mm (VDMA 24563-02)

GENERAL DATA

Construction	balanced spool type
Valve functions	5/2 - 5/3-way CC CO CP
Materials	AL body, spool base, polyamide endcovers, NBR seals
Mounting	by means of screws on the base
Ports	on sub-base
Operating temperature	0° C min. +50° C max
Fluid	filtered air (5 micron or less), without lubrication. If lubricated air is used, it is recommended to use ISOVG32 oil. Once applied the lubrication should never be interrupted.
Size	26 mm 18 mm
Installation	in any position
Operating pressure	P. max 7 bar
Nominal pressure	6 bar
Nominal flow	Qn Size 26 mm = 900 NI/min Qn Size 18 mm = 450 NI/min
Voltage	see coding
Voltage tolerance	± 10%
Power consumption	2W
Class of insulation	class F
Protection	IP54 (IP65 with connector DIN 40050)

CODING EXAMPLE

7	5	1	-	N	1	A	-	P16	-	15	-	W	2	3
----------	----------	----------	----------	----------	----------	----------	----------	------------	----------	-----------	----------	----------	----------	----------

7	SERIES:
5	NUMBER OF WAYS - POSITIONS: 5 = 5/2 6 = 5/3 CC 7 = 5/3 CO 8 = 5/3 CP
1	SIZES: 1 = size 26 mm 2 = size 18 mm
N	SUBBASE: N = sub-base with front outlets
1	PORTS: 1 = G1/4 (Size 26 mm) 2 = G1/8 (Size 18 mm)
A	NUMBER OF SUBBASES: A = 1 * B = 2 * C = 3 * D = 4 * E = 5 * F = 6 * G = 7 * H = 8 * K = 9 * L = 10 * M = 11 * N = 12 * P = 13 * R = 14 * S = 15 *
P16	ACTUATION: 33 = pneumatic, bistable 36 = pneumatic, monostable P11 = electro-pneumatic, bistable P16 = electro-pneumatic, monostable
15	SOLENOID INTERFACE: 15 = 15x15
W	SOLENOID TYPES: W = Series W (24V - 48V DC only) P = Series P **
2	CONNECTION: 1 = wire 300 mm (Series W, 24V DC only) ** 2 = 2 pins (Series W, 24V - 48V DC) 5 = 2 pins+earth (Series P) **
3	SOLENOID VOLTAGE: 3 = 24V DC 4 = 48V DC ** 6 = 110V DC (with Series P solenoids only) ** B = 24V 50/60 Hz (with Series P solenoids only) ** C = 48V 50/60 Hz (with Series P solenoids only) ** D = 110V 50/60 Hz (with Series P solenoids only) **
	NOTES: * complete with the two end blocks ** on request

5/2-way solenoid valve, ISO 26 mm - 18 mm monostable



The Series 7 solenoid valves with interface ISO 26 mm and 18 mm which have electropneumatic actuation and spring return are suitable for mounting on a sub-base. For electrical actuation, 2 types of solenoid, Series W and Series P (available with a wide range of voltages, on request). Connector Mod. 126-800.

The following is supplied:
1x interface seal
2x fixing screws

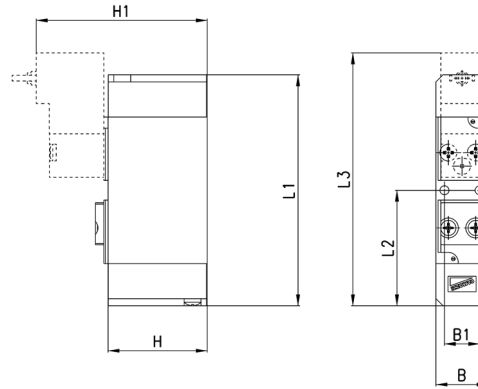
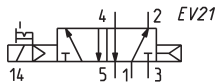

DIMENSIONS

Mod.	Size ISO	B	B1	L1	L2	L3	H	H1	Min. operating pressure
751-000-P16-15-W20	26 mm	26,5	19	99,7	49,85	98,8	39	64,3	3 bar
752-000-P16-15-W20	18 mm	18,5	12,5	82,2	41,1	90	35,2	60,5	3 bar

5/2-way solenoid valves, ISO 26 mm - 18 mm, bistable



The Series 7 solenoid valves with ISO 26 mm and 18 mm interface which have electropneumatic actuation and return are suitable for mounting on a sub-base. For electrical actuation, 2 types of solenoid Series W and Series P (available with a wide range of voltages, on request). Connector Mod. 126-800.

The following is supplied:
1x interface seal
2x fixing screws

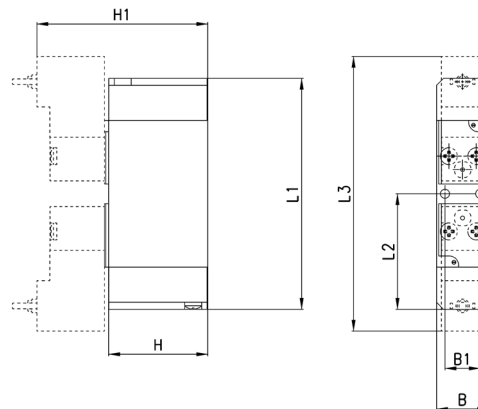
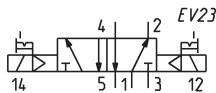

DIMENSIONS

Mod.	Size ISO	B	B1	L1	L2	L3	H	H1	Min. operating pressure
751-000-P11-15-W20	26 mm	26,5	19	99,7	49,85	98,8	39	64,3	2 bar
752-000-P11-15-W20	18 mm	18,5	12,5	82,2	41,1	97,8	35,2	60,5	2 bar

5/3-way solenoid valves, ISO 26 mm - 18 mm



The Series 7 solenoid valves with ISO 26 mm - 18 mm interface which have electropneumatic actuation and spring return are suitable for mounting on a sub-base. For electrical actuation, two types of solenoid Series W and Series P (are available with a large range of voltages, on request). Connector Mod. 126-800.

The following is supplied:
1x interface seal
2x fixing screws

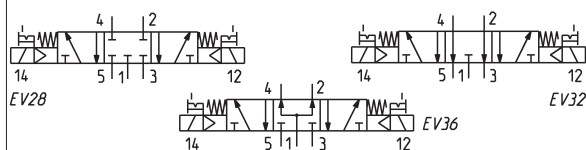
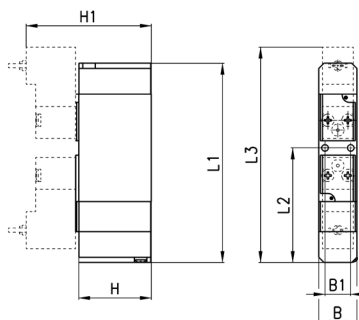

DIMENSIONS

Mod.	Size ISO	B	B1	L1	L2	L3	H	H1	Min. operating pressure	Symbol
761-000-P11-15-W20	26 mm	26,5	19	111,7	61,85	110,8	39	64,3	3 bar	EV28
762-000-P11-15-W20	18 mm	18,5	12,5	96,7	55,6	104,5	35,2	60,5	3 bar	EV28
771-000-P11-15-W20	26 mm	26,5	19	111,7	61,85	110,8	39	64,3	3 bar	EV32
772-000-P11-15-W20	18 mm	18,5	12,5	96,7	55,6	104,5	35,2	60,5	3 bar	EV32
781-000-P11-15-W20	26 mm	26,5	19	111,7	61,85	110,8	39	64,3	3 bar	EV36
782-000-P11-15-W20	18 mm	18,5	12,5	96,7	55,6	104,5	35,2	60,5	3 bar	EV36

5/2-way solenoid valves ISO 26 mm - 18 mm, monostable



The Series 7 solenoid valves with ISO 26 mm and 18 mm interface which have pneumatic actuation and pneumatic spring return are suitable for mounting on a sub-base.

For the correct use of the valve, the pilot pressure must be the same or higher than the operating pressure.

The following is supplied:
1x interface seal
2x fixing screws

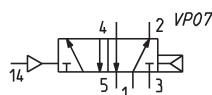
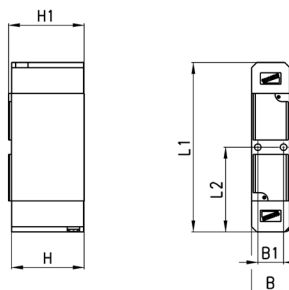

DIMENSIONS

Mod.	Size ISO	B	B1	L1	L2	H	H1	Min. operating pressure
751-000-36	26 mm	26,5	19	99,7	49,85	39	40,5	3 bar
752-000-36	18 mm	18,5	12,5	82,2	41,1	35,2	36,7	3 bar

5/2-way solenoid valves ISO 26 mm - 18 mm, bistable



The Series 7 solenoid valves with ISO 26 mm and 18 mm interface which have pneumatic actuation and return are suitable for mounting on a sub-base.

The following is supplied:
1x interface seal
2x fixing screws

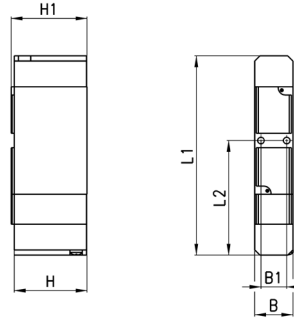
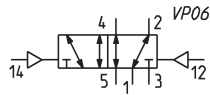

DIMENSIONS

Mod.	Size ISO	B	B1	L1	L2	H	H1	Min. operating pressure
751-000-33	26 mm	26,5	19	99,7	49,85	39	40,5	2 bar
752-000-33	18 mm	18,5	12,5	82,2	41,1	35,2	36,7	2 bar

5/3-way solenoid valves, ISO 26 mm - 18 mm



The Series 7 solenoid valves with ISO 26 mm and 18 mm interface which have pneumatic actuation and mechanical spring return are suitable for mounting on a sub-base.

The following is supplied:
1x interface seal
2x fixing screws

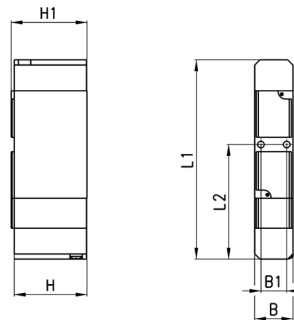
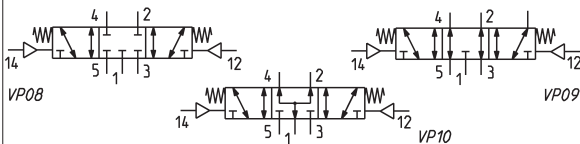

DIMENSIONS

Mod.	Size ISO	B	B1	L1	L2	H	H1	Min. operating pressure	Symbol
761-000-33	26 mm	26,5	19	117,7	61,85	39	40,5	3 bar	VP08
762-000-33	18 mm	18,5	12,5	96,7	55,6	35,2	36,7	3 bar	VP08
771-000-33	26 mm	26,5	19	117,7	61,85	39	40,5	3 bar	VP09
772-000-33	18 mm	18,5	12,5	96,7	55,6	35,2	36,7	3 bar	VP09
781-000-33	26 mm	26,5	19	117,7	61,85	39	40,5	3 bar	VP10
782-000-33	18 mm	18,5	12,5	96,7	55,6	35,2	36,7	3 bar	VP10

End blocks for subbase

End blocks for subbase with conveyed inlets and exhausts and front outlets.



The following is supplied:
1x seal
2x fixing screws

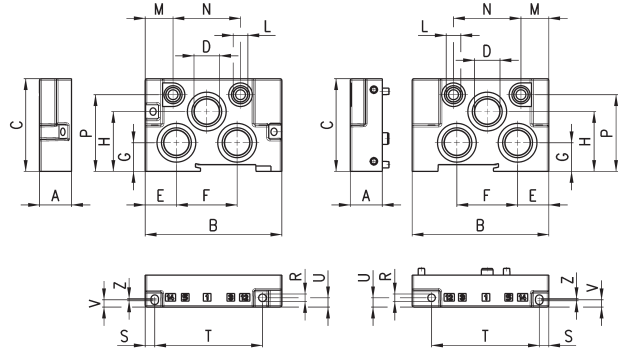

DIMENSIONS

Mod.	Size ISO	A	B	C	D	E	F	G	H	L	M	N	P	R	S	T	U	V	Z
701C-HN1	26 mm	27	107	65	G1/2	23	60	24,5	43	G1/8	21,5	58	55,5	4,5	7,5	61,5	6	6,2	4
702C-HN2	18 mm	19	81	55	G3/8	18,5	36	17	35,5	G1/8	16,5	40	45,5	4,5	4,65	63,85	5,5	4,35	1,3

Intermediate supply module

Intermediate supply module for manifold bases with conveyed inlets and exhausts and front outlets.



The following is supplied:
1x seal
2x fixing screws

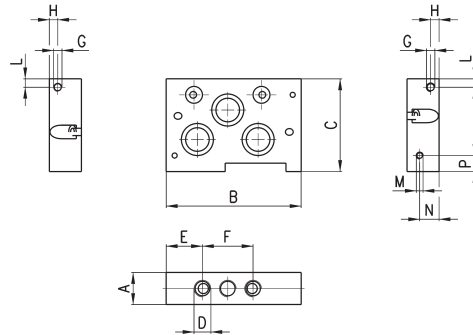

DIMENSIONS

Mod.	Size ISO	A	B	C	D	E	F	G	H	L	M	N	P
701C-N1N	26 mm	27	100	65	G1/4	29	42	M5	6,5	10	M4	10	10
702C-N2N	18 mm	19	81	55	G1/8	22,5	28	M5	5	5	M4	11,5	9,5

Subbase for manifolds

Manifold subbase with conveyed inlets and exhausts and front outlets.



The following is supplied:
1x seal
2x fixing screws

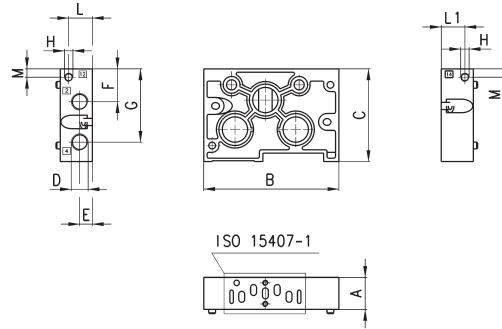

DIMENSIONS												
Mod.	Size ISO	A	B	C	D	E	F	G	H	L	L1	M
701C-N1A for separated pilots	26 mm	27	107	65	G1/4	11	23	53	M5	20,7	20,7	6,5
702C-N2A for separated pilots	18 mm	19	81	55	G1/8	7,5	19,5	44,5	M5	13	6	7
701C-N1C	26 mm	27	107	65	G1/4	11	23	53	M5	20,7	20,7	6,5
702C-N2C	18 mm	19	81	55	G1/8	7,5	19,5	44,5	M5	13	6	7

Diaphragm cover for subbase

Diaphragm for subbase with conveyed inlet and exhausts and side outlets.

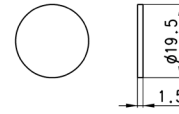

Mod.

701C-N1A-TP

702C-N2A-TP

Excluder tap for subbase

The following is supplied:

- 1x seal
- 2x screws

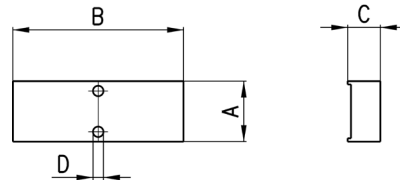

DIMENSIONS

Mod.	Size ISO	A	B	C	D
701-TP	26 mm	26,5	61,7	10	4,2
702-TP	18 mm	18,5	52,2	10	3,2

Interface between ISO 01 and ISO 02

The following is supplied:

- 1x tap S2610 3/8
- 5x OR
- 2x screws

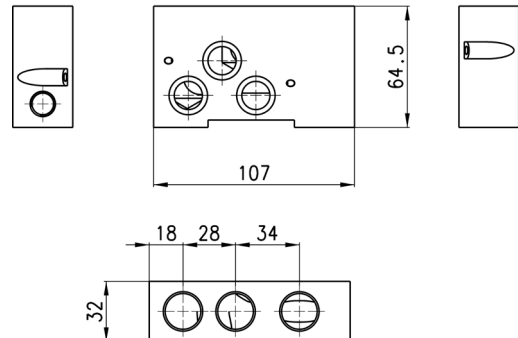

Mod.

701C-702C-A