

# Series 94 and 95 stainless steel mini-cylinders

Single-acting and double-acting, magnetic  
 Series 94:  $\varnothing$  16, 20, 25 mm  
 Series 95:  $\varnothing$  25 mm, cushioned



- » In compliance with Cetop RP52-P and DIN/ISO 6432 standards
- » Clean design
- » Stainless steel AISI 304 and AISI 316

**Series 94 and 95 cylinders are suitable for use in the off-shore, naval, pharmaceutical, nuclear and food industries.**

Their construction enables the replacement of all seals. Series 95 is normally equipped with adjustable end-stroke cushioning by means of a screw on the end block. In addition both Series 94 and 95 are equipped with a mechanical cushioning in order to make the impact of the piston less noisy as it reaches the end of the stroke.

## GENERAL DATA

<b>Construction</b>	end blocks secured to the tube
<b>Operation</b>	single-acting and double-acting
<b>Materials</b>	end blocks and rod in stainless steel AISI 316, seals in NBR, plastic guiding element, NSF H1-certified lubricant Series 94: tube in stainless steel AISI 304 Series 95: tube in stainless steel AISI 316
<b>Mounting</b>	several types of cylinders clamps available
<b>Strokes min - max</b>	10 ÷ 500 mm
<b>Operating temperature</b>	0° - 80°C (with dry air -20°C)
<b>Operating pressure</b>	1 ÷ 10 bar
<b>Speed</b>	10 ÷ 1000 mm/sec (without load)
<b>Fluid</b>	clean air, without lubrication. If lubricated air is used, it is recommended to use oil ISOVG32. Once applied the lubrication should never be interrupted.

**STANDARD STROKES FOR MINICYLINDERS SERIES 94 AND 95**

- = single-acting
- ✕ = double-acting

STANDARD STROKES		10	25	40	50	80	100	125	160	200	250	300	320	400	500
94	16	✕✕	✕✕	✕✕	✕✕	✕	✕	✕	✕	✕					
94	20	✕✕	✕✕	✕✕	✕✕	✕	✕	✕	✕	✕	✕	✕			
94	25	✕✕	✕✕	✕✕	✕✕	✕	✕	✕	✕	✕	✕	✕	✕	✕	✕
95	25	✕	✕	✕	✕	✕	✕	✕	✕	✕	✕	✕	✕	✕	✕

**CODING EXAMPLE**

<b>94</b>	<b>N</b>	<b>2</b>	<b>A</b>	<b>16</b>	<b>A</b>	<b>100</b>
<b>94</b>	SERIES 94 = magnetic 95 = magnetic, cushioned					
<b>N</b>	VERSION N = standard					
<b>2</b>	OPERATION 1 = single-acting, front spring 2 = double-acting 3 = double-acting, through-rod		PNEUMATIC SYMBOLS CS06 (S. 94) CD08 (S. 94) - CD09 (S. 95) CD12 (S. 94) - CD13 (S. 95)			
<b>A</b>	MATERIALS A = stainless steel, seals in NBR V = stainless steel, all seals in FKM (150°C)					
<b>16</b>	BORE 16 = 16 mm - 20 = 20 mm - 25 = 25 mm					
<b>A</b>	TYPE OF DESIGN A = standard with locking ring for end cap Mod. V and piston rod lock nut Mod. U					
<b>100</b>	STROKE (see the table)					
	= standard V = rod seal in FKM					

**PNEUMATIC SYMBOLS**

The pneumatic symbols which have been indicated in the CODING EXAMPLE are shown below.

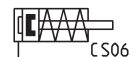
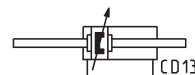
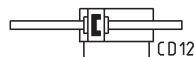
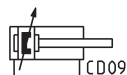
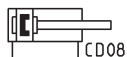

**ACCESSORIES FOR STAINLESS STEEL MINICYLINDERS SERIES 94 AND 95**



Foot mount Mod. B



Flange bracket Mod. E

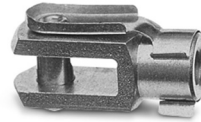

Trunnion bracket Mod. I

 Rod fork end  
Mod. G-94/90

 Swivel ball joint  
Mod. GA-94/90

 Piston rod lock nut  
Mod. U-94/90

 Nose nut Mod. V-94 and  
Mod. U-90



All accessories are supplied separately, except for piston rod lock nut Mod. U

Cylinders Series 94 and 95

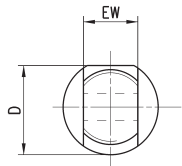
With threaded front and rear end blocks

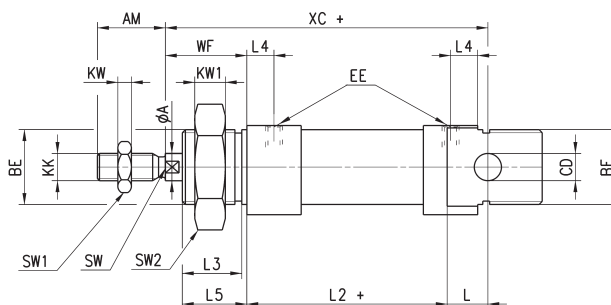

+ = add the stroke



DIMENSIONS

Mod.	Ø	A	AM	BE	CD	D	EE	EW	KK	KW	KW1	L	L2	L3	L4	L5	SW	SW1	SW2	WF	XC
<b>94</b>	94	6	16	M16x1.5	6	21.2	M5	12	M6	4	5	9	51	14	5.5	15	5	10	24	22	82
<b>94</b>	94	8	20	M22x1.5	8	26.2	G1/8	16	M8	5	5	12	59	17.5	8	19	7	13	32	24	95
<b>94-95</b>	94-95	10	22	M22x1.5	8	32.5	G1/8	16	M10x1.25	6	5	12	64	18.5	7.5	20	8	17	32	28	104

Cylinders Series 94 and 95 - through-rod

With threaded end blocks

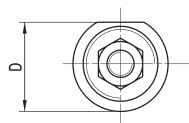

+ = add the stroke once  
++ = add the stroke twice

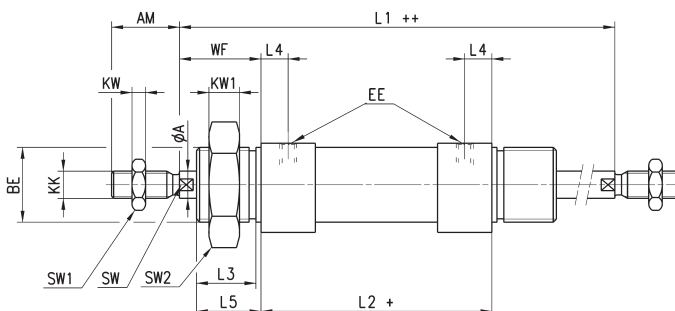

DIMENSIONS

Mod.	Ø	A	AM	BE	D	EE	KK	KW	KW1	L1	L2	L3	L4	L5	SW	SW1	SW2	WF
<b>94</b>	94	6	16	M16x1.5	21.2	M5	M6	4	5	100	56	14	5.5	15	5	10	24	22
<b>94</b>	94	8	20	M22x1.5	26.2	G1/8	M8	5	5	116	68	17.5	8	19	7	13	32	24
<b>94-95</b>	94-95	10	22	M22x1.5	32.5	G1/8	M10x1.25	6	5	125	69	18.5	7.5	20	8	17	32	28

**Foot mount Mod. B**

Material: stainless steel 304

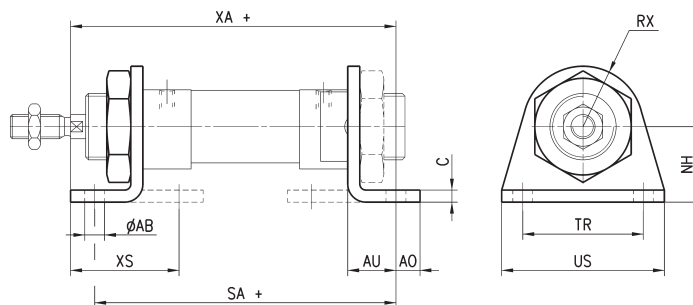
 Supplied with:  
 2x feet  
 1x nut

+ = add the stroke

**DIMENSIONS**

Mod.	Ø	ØAB	XS	XA+	SA+	AO	AU	C	RX	TR	US	NH
<b>B-94-12-16</b>	16	5,5	32	91	82	6	13	3	13	32	42	20
<b>B-94-20-25</b>	20	6,6	36	108	100	8	16	4	20	40	54	25
<b>B-94-20-25</b>	25	6,6	40	113	101	8	16	4	20	40	54	25

**Flange bracket Mod. E**

Material: stainless steel 304

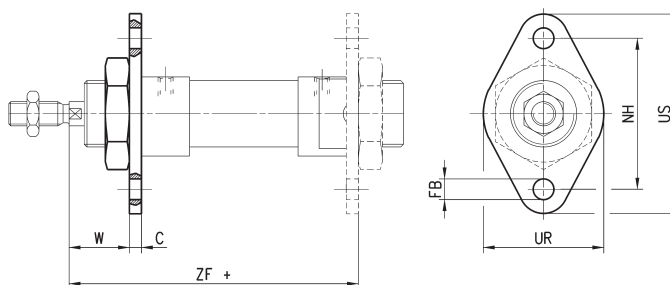
 Supplied with:  
 1x flange

+ = add the stroke

**DIMENSIONS**

Mod.	Ø	W	C	ZF+	FB	UR	TF	UF
<b>E-94-12-16</b>	16	19	3	81	5,5	30	40	53
<b>E-94-20-25</b>	20	20	4	96	6,6	40	50	66
<b>E-94-20-25</b>	25	24	4	101	6,6	40	50	66

**Trunnion Bracket Mod. I**

Material: stainless steel 304

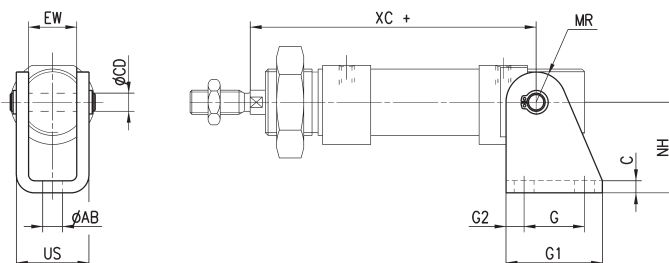

**DIMENSIONS**

Mod.	Ø	AB	C	CD	EW	G	G1	G2	MR	NH	US	XC+
<b>I-94-12-16</b>	16	5,5	3	6	12	15	25	5	7	27	18,1	82
<b>I-94-20-25</b>	20	6,6	4	8	16	20	32	6	10	30	24,1	95
<b>I-94-20-25</b>	25	6,6	4	8	16	20	32	6	10	30	24,1	104

Rod Fork End Mod. G-94/90

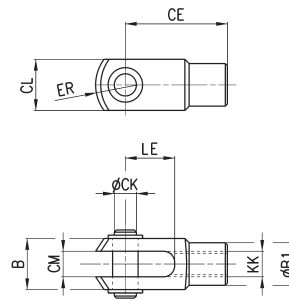

ISO 8140  
Material: stainless steel 303



DIMENSIONS											
Mod.	Ø	CK	LE	KK	CM	ER	CE	CL	B	B1	
<b>G-94-12-16</b>	16	6	12	M6x1	6	7	24	12	16	10	
<b>G-94-20</b>	20	8	16	M8x1,25	8	10	32	16	22	14	
<b>G-90-25-32</b>	25	10	20	M10x1,25	10	12	40	20	26	18	

Swivel Ball Joint Mod. GA-94/90



ISO 8139  
Materials:  
- stainless steel 304 bracket  
- stainless steel 420 spherical ring  
- sintered bronze bushing

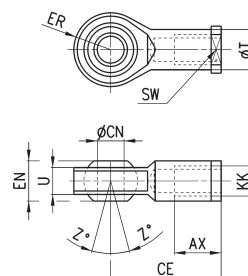

DIMENSIONS											
Mod.	Ø	CN	U	EN	ER	AX	CE	KK	T	Z	SW
<b>GA-94-12-16</b>	16	6	7	9	10	12	30	M6x1	10	6,5	11
<b>GA-94-20</b>	20	8	9	12	12	16	36	M8x1,25	12,5	6,5	14
<b>GA-90-32</b>	25	10	10,5	14	14	20	43	M10x1,25	15	6,5	17

Piston Rod Lock Nut Mod. U-94/90



ISO 4035  
Material: stainless steel 304

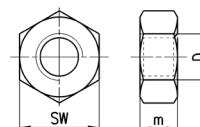

DIMENSIONS				
Mod.	Ø	D	m	SW
<b>U-94-12-16</b>	16	M6x1	4	10
<b>U-94-20</b>	20	M8x1,25	5	13
<b>U-90-25-32</b>	25	M10x1,25	6	17

Nose Nut Mod. V-94 and Mod. U-90



ISO 4035  
Material: stainless steel 304

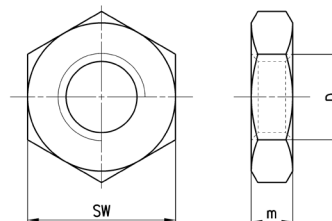

DIMENSIONS				
Mod.	Ø	D	m	SW
<b>U-90-50-63</b>	16	M16x1,5	8	24
<b>V-94-20-25</b>	20-25	M22x1,5	10	32